



Installation Guide

SILENCE CLOUD

Suspension system

YOU WILL NEED



BRAIDED WIRE



ADJUSTABLE CLIPS



CEILING EYE HOOKS
(INDICATIVE: CHOOSE TYPE)

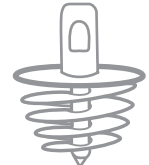

SPRINGS

step 1 & 2

Diagram A

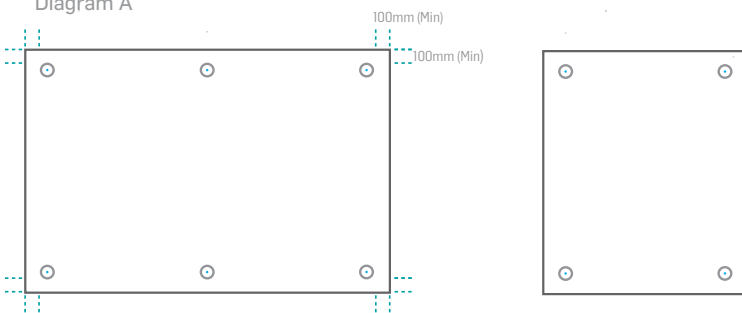

step 3

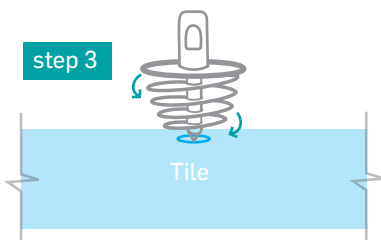

step 4

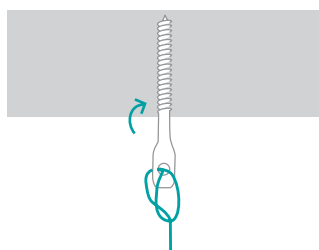

step 5

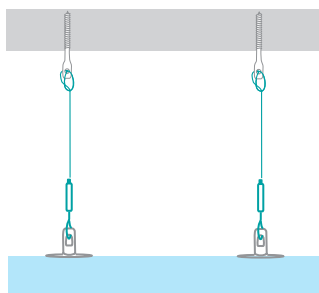
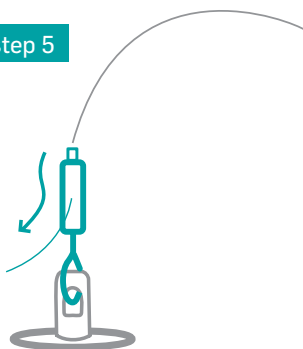

step 1

Identify SOLID fixing points in the ceiling for suspension points. For a 2200 x 1200 panel use a minimum of 6 fixing points, and for a 1200 x 600 panel use a minimum of 4. For panels smaller than 1200 by 600, the number of springs can be reduced to a minimum of 3.

* Ideally these fixing points will correspond to the central points of the springs as shown in Diagram A.

*The spring layout as described in Diagram A may need to be altered to match SOLID fixing points available

step 2

Lay out the springs out on the back of the Panel as per Diagram A.

*If available solid fixing points in the ceiling don't correspond, modify layout as necessary.

step 3

Screw the springs into the back of the panel making sure the top circle is flush.

step 4

Screw the ceiling Eyehooks into the fixing points as identified in STEP 1. Attach the looped wire to the eyehooks

step 5

SUPPORT the panel at the correct suspension height Attach one Adjustable Clip to each of the Springs' hook. Thread one end of the braided wire through the adjustable clip.

step 6

Using a level, adjust the wires to fine-tune the suspension height by pressing the end of the clip.

Remove the support. The panel is now suspended.

SITE SPECIFIC BRACING: The panels can withstand swingin in a seismic event. Depending on the site, and the suspension length of the braided wire, the panels may need Bracing for seismic restraint.



Installation Guide

SILENCE CLOUD

Ceiling Direct Fix

YOU WILL NEED



MAGNETS

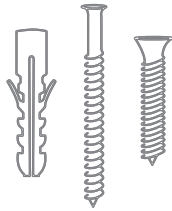

SCREWS

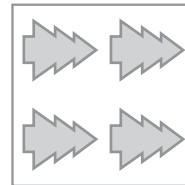

STEEL FIXING PLATES



GLUE

Diagram A

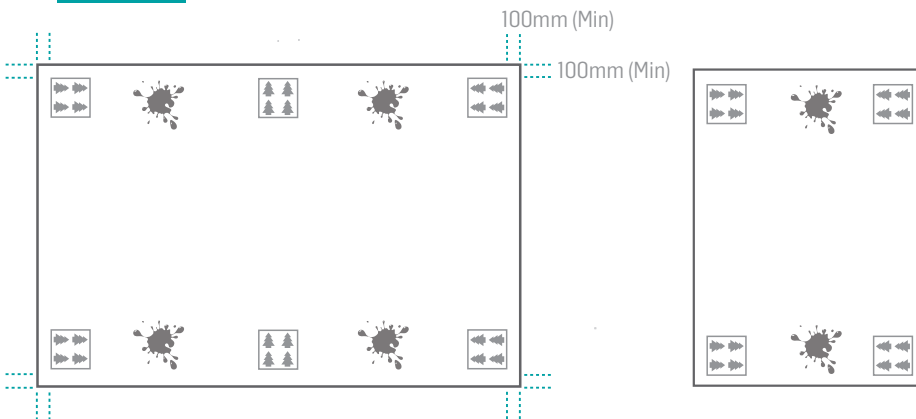

step 1

Identify SOLID fixing points in the ceiling for suspension points.

* Ideally these will correspond to the centre of the Steel Fixing Plates as shown in Diagram A. For a 2200 x 1200 panel use a minimum of 6 fixing points, and for a 1200 x 600 panel use a minimum of 4. For panels smaller than 1200 by 600, the number of plates can be reduced to a minimum of 3.

*The plate layout as described in Diagram A may need to be altered to match SOLID fixing points available

step 2

Bend the spikes of the Steel Fixing Plates out to 30°.

Lay the Steel Fixing Plates out on the back of the Panel as per Diagram A. Note the spike direction layout. *If available solid fixing points in the ceiling don't correspond, modify layout as necessary.

step 3

Apply glue - FastGrab adhesive or equivalent (waterbased, low VOC) - to the Steel Plates and slide them into the back of the panel. Ensure that they are flush.

step 4

Screw the magnets into the fixing points in the ceiling as identified in STEP 1.

step 5

Apply thick blobs of adhesive to the back of the panel as per Diagram A. Elevate the panels to the magnets and attach. Take care in panel placement as movement is limited. The panels are now installed

step 3



step 4



step 5





Installation Guide

SILENCE CLOUD

Wall Direct Fix

YOU WILL NEED

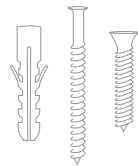

WALL SCREWS
x 16

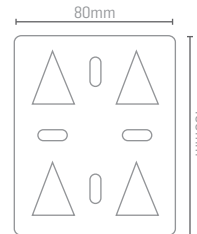

IMPLALER
x 4

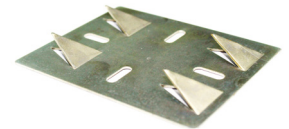

step 1

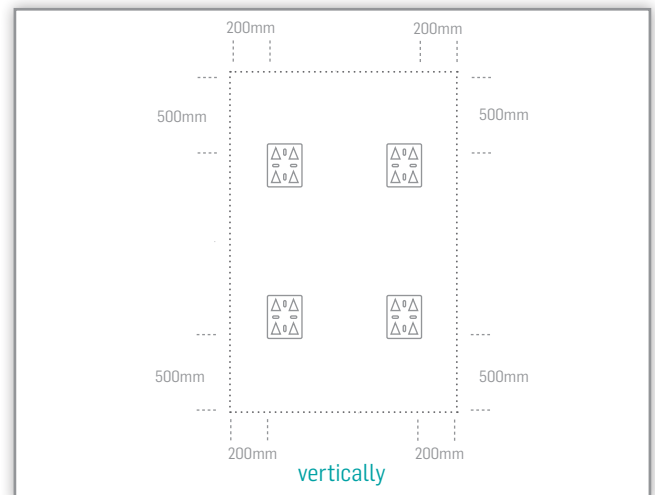
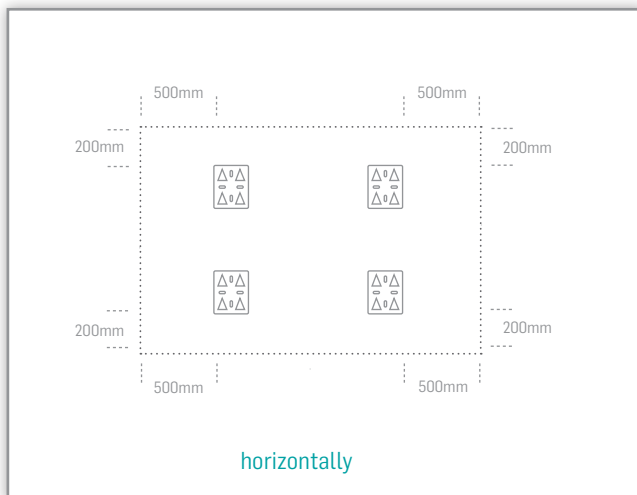

step 2 side profile

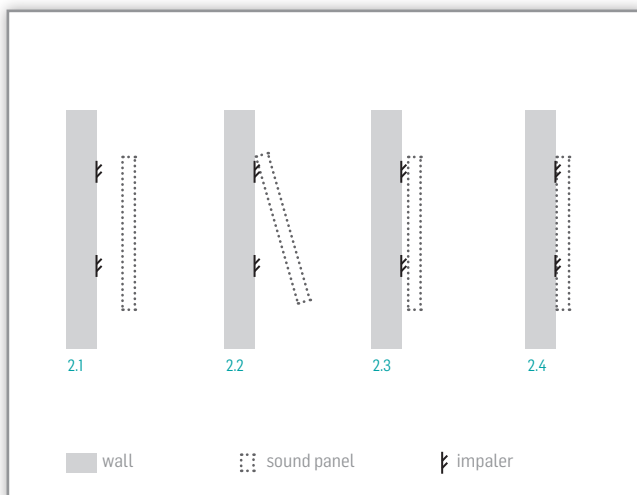

step 1

Screw the plates onto the wall (4 plates per panel) with the spikes pointed upwards.

step 2

Line up panel and raise by 10mm before pushing forward and down onto plate. Some adjustment in height is possible.



Installation Guide

SILENCE CLOUD

Suspension system - Braced

YOU WILL NEED



BRAIDED WIRE
X 6



ADJUSTABLE CLIPS
X 6



CEILING EYE HOOKS
X 6
(INDICATIVE: CHOOSE TYPE)

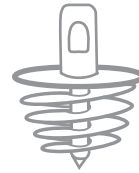

SPRINGS
X 6

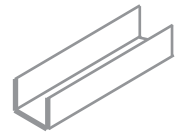

STEEL STUD AND TRACK
(AS APPLICABLE FOR COMPRESSION POST)

Diagram A

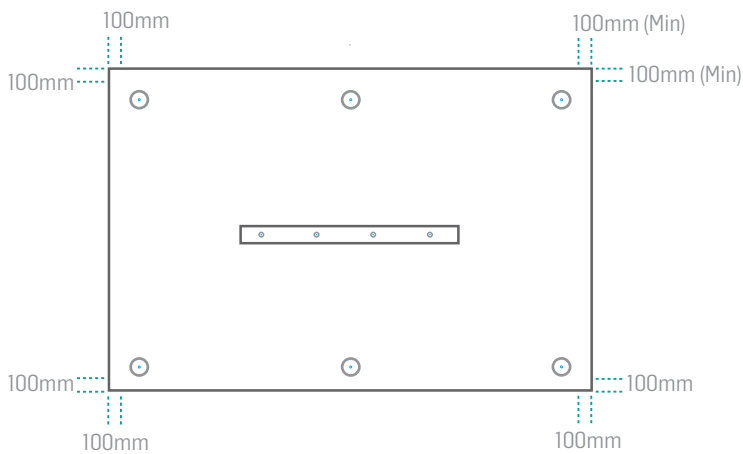

step 1

Identify SOLID fixing points in the ceiling for suspension points.

* Ideally these will correspond to the **central points** of the springs as shown in Diagram A.

*The spring layout as described in Diagram A may need to be altered to match SOLID fixing points available

step 2

Lay out the springs out on the back of the Panel as per Diagram A or modified layout. Six in total.

*If available solid fixing points in the ceiling don't correspond, modify layout as necessary.

step 3 - as applicable

If a compression post is required, place and glue piece of steel track in centre of panel

step 4

Screw the springs into the back of the panel making sure the top circle is flush.

step 5

Screw the ceiling Eyehooks into the fixing points as identified in STEP 1 Attach the looped wire to the eyehooks.

step 6

Attach one Adjustable Clip to each of the Springs' hook. SUPPORT the panel at the correct suspension height and thread the end of the braided wire through the adjustable clip. Adjust the wires to fine-tune the suspension height by pressing the end of the clip.

step 9

Remove the external support.

step 10 - as applicable

Fit Compression Post by fixing the Steel Stud to the track on back centre of Panel and to Structure above.

step 4

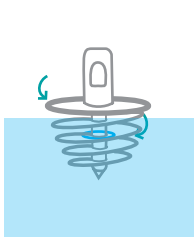

step 5

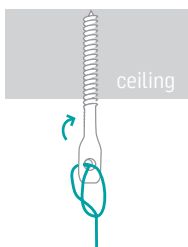

step 6



step 8

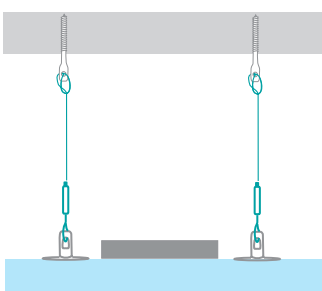

step 10

